

RPT Robotic Pool Cleaner

Installation and Operating Instructions



Rainbow Pool Products

PO Box 2388, Mansfield Qld 4122

Telephone STD 61-7-3849 5385

Facsimile STD 61-7-3849 5384

Email: info@rainbowpoolproducts.com.au

Web: www.rainbowpoolproducts.com.au



ASTRALPOOL 

Quick Start Guide

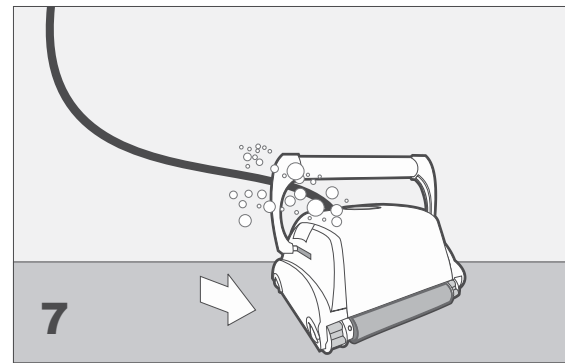
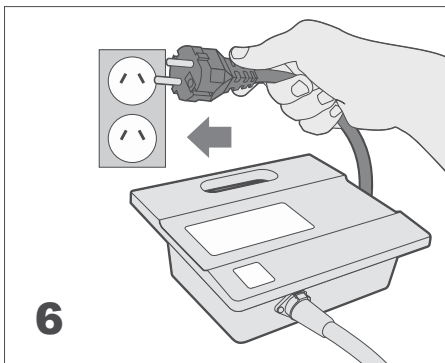
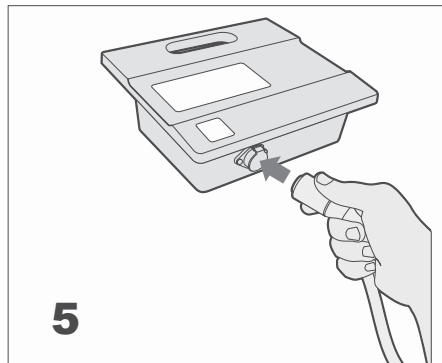
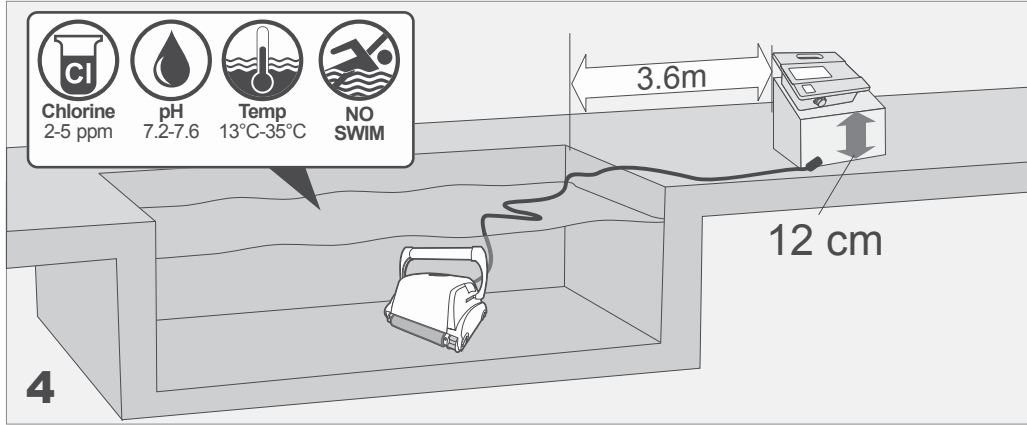
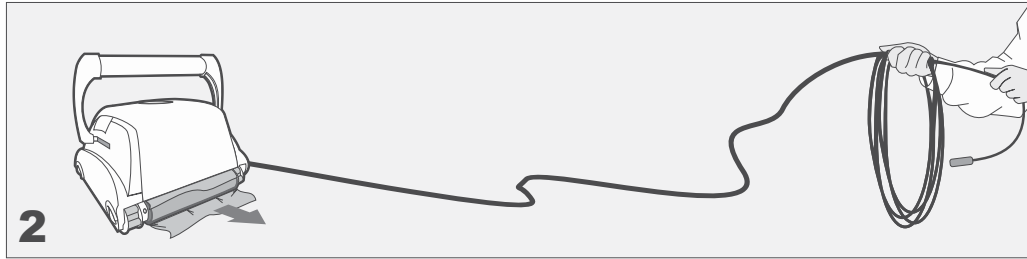
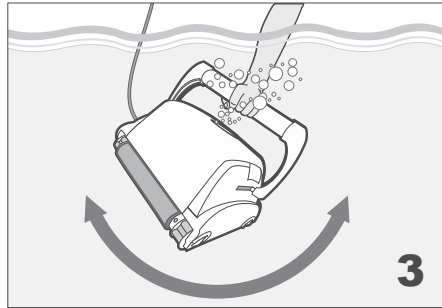
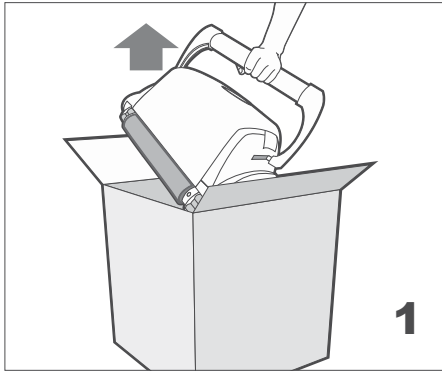

Float Installation

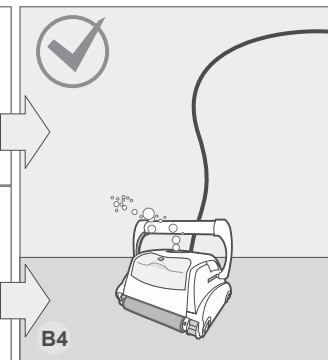
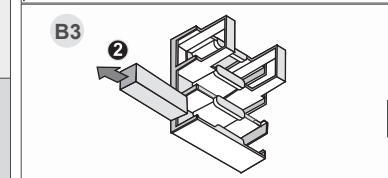
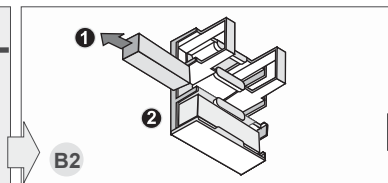
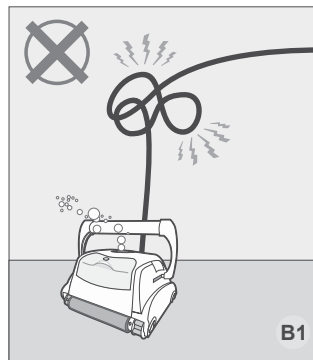
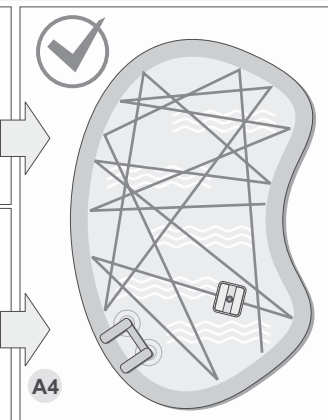
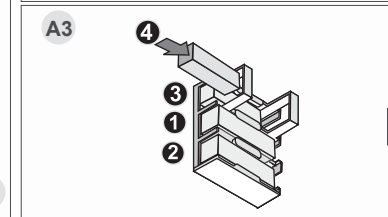
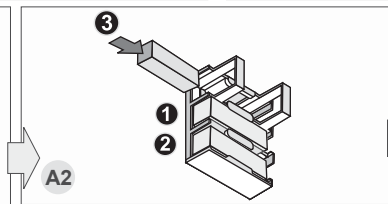
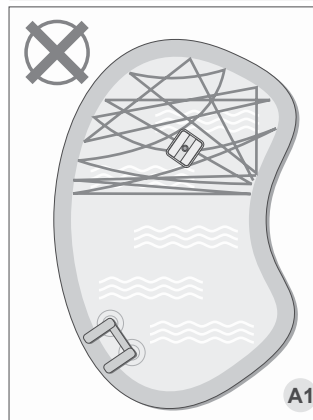
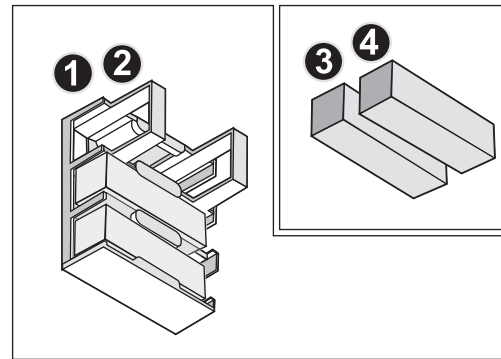
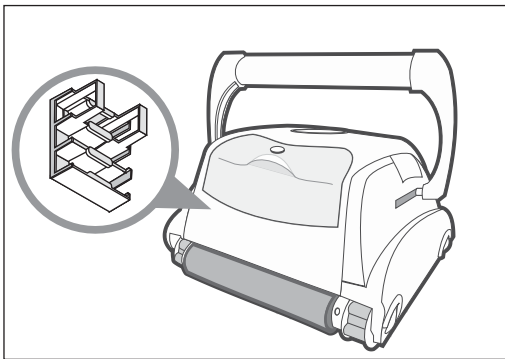

Contents

Quick Start Guide

Safety

Introduction

System Overview

How the Robotic Cleaner Cleans Your Pool

Operating Conditions

Components

Cleaner And The Main Parts

Power and Control Unit

Operation

Before First Use

Placing Cleaner Unit into the Water

Starting the Robotic Cleaner

Cleaning Cycle

Stopping Robotic Cleaner Operation

Pulling Cleaner Unit out of the Water

Maintenance

Cleaning Filter

Storing the Robotic Cleaner

Checking Water Outlet Propeller

Important Tips

Cable Care

Troubleshooting

Warranty Terms and Conditions

Warranty Claims

Exclusions and Limitations

IMPORTANT SAFETY INSTRUCTIONS READ AND FOLLOW ALL THE INSTRUCTIONS

CAUTION: Do not plug the power supply into a grounded outlet or do not switch the pool cleaner "ON" if it is not fully immersed in water. Operating the cleaner out of water will cause severe damage immediately and will result in loss of warranty.

Allow the cleaner to remain in the pool for 15 to 20 minutes following the end of its cleaning cycle. This will allow the motors to cool adequately. Do not leave the cleaner in the pool all the time. Always remember to turn the power supply "OFF" and unplug it from the power outlet before removing the cleaner from the pool.

WARNING: The cleaner must not be used when people are in the water. For use with swimming pool only

Safety Note

- The unit must be supplied through a residual current device (RCD) having a rated residual operating current not exceeding 30 mA
- The connection to the branch circuit should be consistent with the local and national wiring rules (electrical code).
- Mishandling of the unit can result in leakage of lubricants.
- If the supply cord is damaged, it must be replaced by the manufacturer's service agent or a qualified and trained person in order to avoid hazards.



This appliance is not intended for use by persons (including children) with reduced physical, sensory or mental capabilities, or lack of experience and knowledge, unless they have been given supervision or instruction concerning use of the appliance by a person responsible for their safety. Children should be supervised to ensure that they do not play with the appliance.



WARNING: A Ground Fault Current Interrupter (GFCI-USA) or a Residual Current Device (RCD-EUROPE) must be installed to protect your electric outlet and prevent any possible electric shock.

SAVE THESE INSTRUCTIONS

System Overview

The robotic cleaner sweeps the pool floor and walls to collect dirt and debris into its internal filters. This user manual explains how to operate the robotic cleaner, including cleaning, maintenance and storage procedures.

Note:

This manual reviews several robotic cleaner models. There are some variations in components according to specific model.

How the Robotic Cleaner Cleans Your Pool

After the robotic cleaner is placed in the pool and activated, it operates according to the program set via the power and control unit. The robotic cleaner moves along the floor and walls of the pool, covering the entire area of the pool floor and walls. When the robotic cleaner has finished its program, it remains inactive on the pool floor.

Note:

Wall climbing is an optional feature. When the wall climbing feature is enabled, the robotic cleaner climbs the wall at intervals according to its internal program. The robotic cleaner ability to climb over stairs in swimming pool is subject to stair geometry and material.

Operating Conditions

The robotic cleaner is intended for use in swimming pools in the following conditions:

- Temperatures ranging from 13°C-35°C, recommended temperature is between 22°C-32°C.
- Water pH: 7.2-7.6
- Chlorine level: pool is maintained according to the pool manufacturer's instructions. (recommended 2-5 ppm)

Note:

Failure to maintain the pool according to the recommended operating conditions could prevent the robotic cleaner from functioning properly. Remove the cleaner out of water when performing "Chemical Shock Treatment" to the pool water.

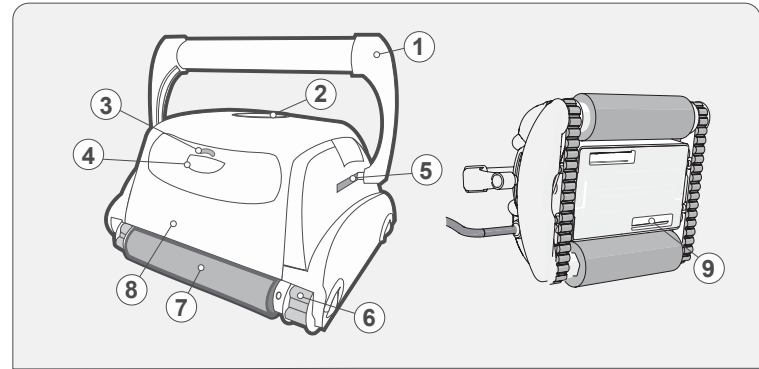

- 1) Handle
- 2) Outlet Top
- 3) Filter Lock Release
- 4) Filter Lid
- 5) Handle Lock Mechanism
- 6) Drive Track
- 7) Scrubbing Brush
- 8) Unit Body
- 9) Water Inlet

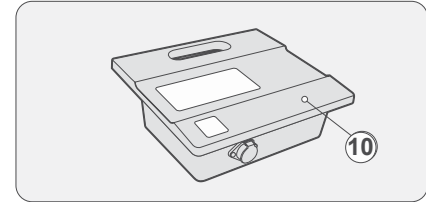

10

Power and Control Unit

The power and control unit is connected to the robotic cleaner via the floating cable. The unit is powered by AC power (1) and supplies low voltage and commands to the cleaner unit through the outlet socket (2).

The unit features a control panel (3) with various controls to operate the robotic cleaner.

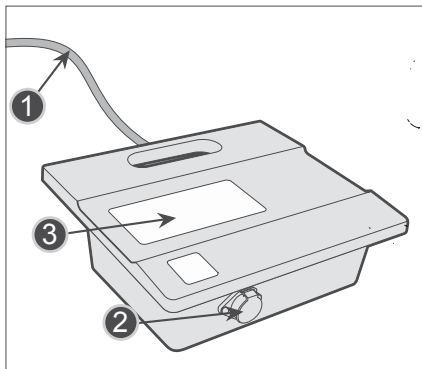

Contents of Packing Box

The robotic cleaner is packed in a box containing:

- Robotic cleaner and floating cable
- Power and control unit
- User manual

Before First Use

Adjusting Suction Height: Positioning the suction inlet (2) close to the pool surface increases the suction power and the cleaning quality. Lowering the suction inlet could result in interference with obstacles on the swimming pool floor or walls.

Use a screw driver to adjust the suction inlet position knob (1).

- IN – pulls the suction inlet away from the pool surface and reduces the suction power.
- OUT – brings the suction inlet closer to the pool surface and increases the suction power.

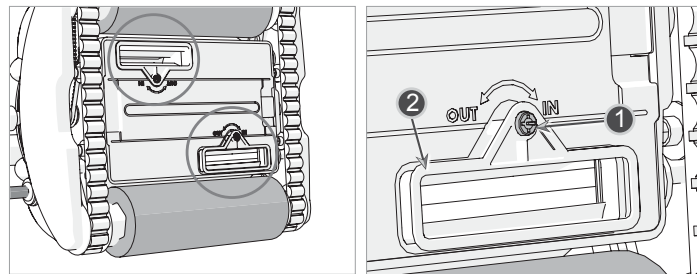

Adjusting Floating Handle

On wall climbing models, set the floating handle:

1. Press the lock button (1 or 2 according to the model) to release the handle lock.
2. Place the handle (3) diagonally at maximum position.
3. Repeat steps 1 and 2 on the other side of the cleaner unit.

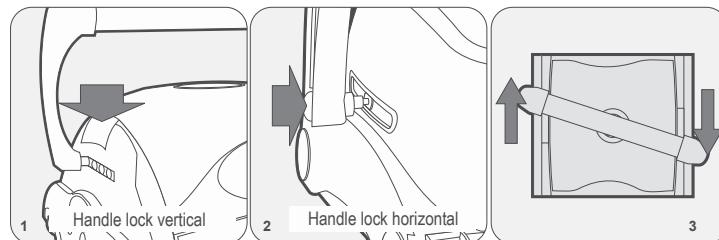

Aquacontrol Power Supply Specifications

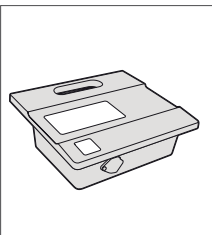

| | |
|------------------------|--------------------------|
| Dimensions (W * D * H) | 273mm * 242mm * 90mm |
| Weight | 1.9 Kg |
| Electrical | |
| Input rating | 100-240V~, 50/60Hz, 210W |
| Output rating | 29V ,6.3A. |
| Storage temperature | -10° C - 60° C |
| Operating temperature | 0° C - 45° C |
| Ingress protection | IP54 |

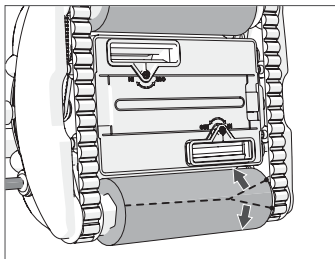

Removing Brush Covers

The robotic cleaner is shipped with a protective cover over the scrubbing brushes. Carefully remove the nylon covers from the scrubbing brushes.

CAUTION: Do not use a sharp tool to remove the cover as it could harm the brushes.

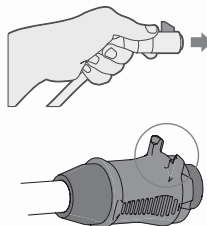
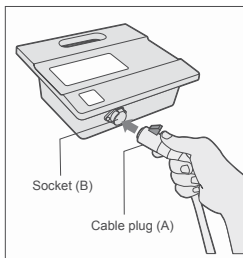
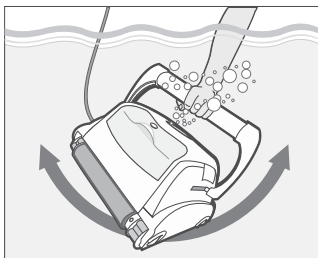
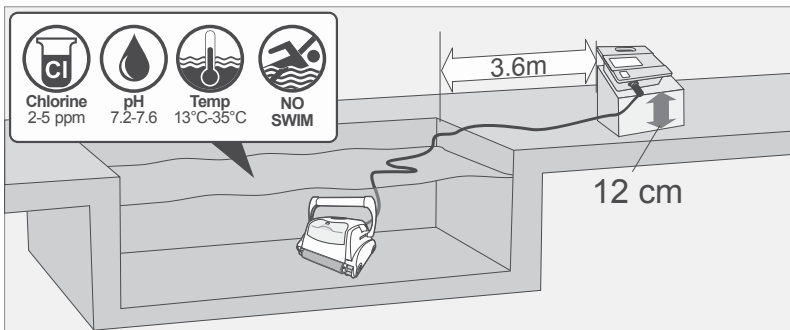

Placing the Power and Control Unit

4. Place the power and control unit at least 3.6 meters from the pool and at least 12 cm inches above the surface.

CAUTION: The power and control unit must not be exposed to water or to direct sunlight.

5. Release floating cable plastic ties, which are used to secure the cables during shipping, by pressing plastic snap on the tie.

Before placing the cleaner unit in the water

1. Make sure there are no people in the pool.
2. Make sure that the filters are clean.
3. Make sure the pool conditions are met; (see "Operating Conditions").

Placing Cleaner Unit into the Water

1. Unroll the floating cable. It is recommended to extend a length of cable that is equal to the pool diagonal size plus an additional two meters.
2. Place the cleaner unit in the pool.
3. Let the robotic cleaner sink to the bottom of the pool.
Do not start operation before the robotic cleaner is settled on the pool floor.
4. Spread the floating cable across the pool. Make sure that only the required length of cable is spread across the pool. Smooth out coils or twists in the cable. Roll extra cable outside the pool near the power and control unit.
5. Connect the floating cable (A) to the socket (B) located on the power and control unit.

CAUTION: Operating the cleaner out of water causes immediate severe damage and results in loss of warranty.

Starting the Robotic Cleaner

Connect the power and control unit to the wall socket (1). The Operation LED is lit (4) and the robotic cleaner starts its cleaning program.

If the power and control unit is already connected to the AC socket, the Operation LED flashes (5) to indicate that the robotic cleaner is in standby mode.

Press the Operation button (6). The Operation LED turns on (6) and the robotic cleaner starts the cleaning program.

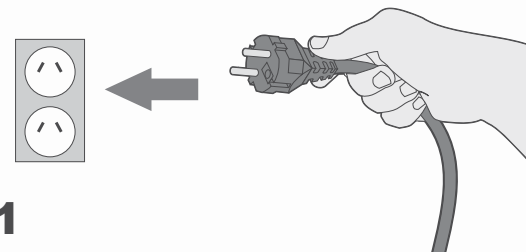

Cleaning Cycle

During the cleaning cycle, the robotic cleaner:

- Moves across the pool floor picking up dirt and debris.
- Changes direction and rotates automatically.

Note: *The robotic cleaner might occasionally stop moving for a few seconds. This is part of normal operation, not a malfunction.*

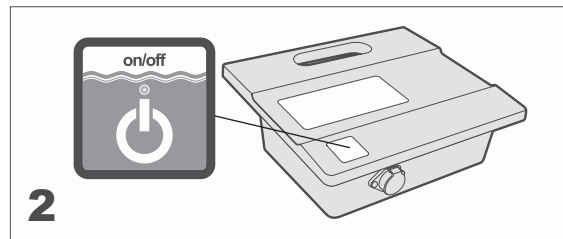

Stopping Robotic Cleaner Operation

The robotic cleaner moves automatically to STANDBY after every cleaning cycle and the operation LED starts flashing (5).

To stop the cleaner operation during a cleaning cycle, press the operation button (7) once. The operation LED starts flashing (7) and the cleaner is in standby mode.

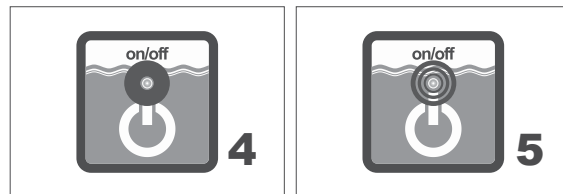

Pulling Cleaner Unit out of the Water

1. Unplug the floating cable from the power and control unit.
2. Pull up on the floating cable to pull the cleaner unit closer until it is possible to take hold of the handle.
3. Using the handle, lift the cleaner unit out of the pool.

CAUTION: *Do not use the floating cable to lift the cleaner unit out of the water.*

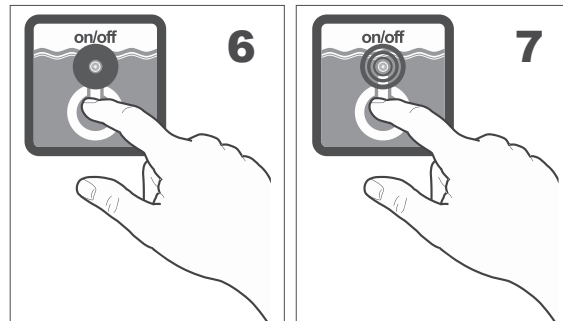

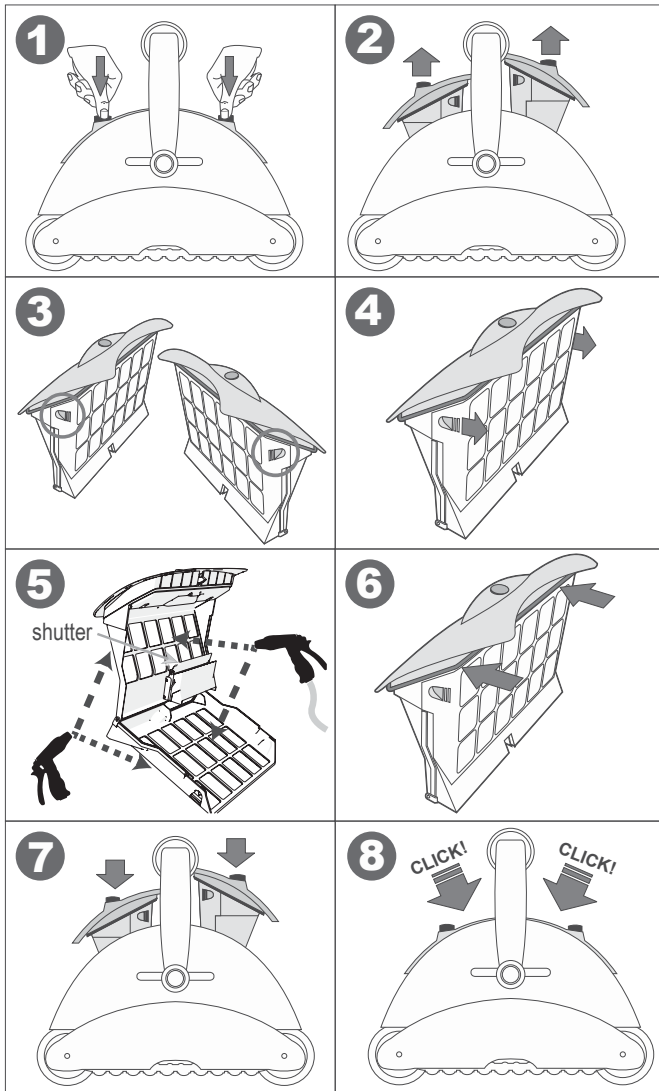

Cleaning the Filters

The two filters must be cleaned after each cleaning cycle.

1. Release the filter and pull it out of the cleaner unit. (1), (2)
2. Pull the filter door against the filter housing to open the filter case. (3), (4)
3. Spray water on the outer sides of the filter and then spray water towards the inner side of the filter to clean all the dirt and debris. (5)
4. Verify that the small plastic shutter (2) is in place and not broken, then close the filter. (6)
5. Insert the filter back into its location until a click is heard to secure the filter in place. (7), (8)

Storing the Robotic Cleaner

Follow these instructions to store the robotic cleaner when not in use:

1. Disconnect the power cord from the wall outlet.
 2. Disconnect the floating cable from the power and control unit.
 3. Spread out the floating cable and release any twists in the cable.
 4. Wash the cleaner unit interior space with fresh water and let it dry.
 5. Roll the floating cable and place it ON THE CLEANER unit.
- Caution: DO NOT ROLL the floating cable ON THE HANDLE of the cleaner unit.**
6. Store the robotic cleaner components in a dry, closed location.
 7. Verify that the power and control unit is not exposed to water.

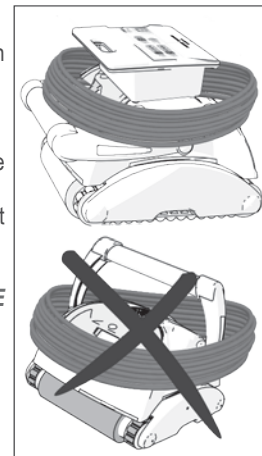

Checking Water Outlet Propeller

It is recommended to periodically clean debris and hair from the propeller of the water outlet:

1. Remove the screws (3) that holds water outlet cover (2).
2. Remove the water outlet cover (2).
3. Clean any hairs, dirt, or debris.
4. Verify that the propeller (1) is not broken.
5. Return the cover (2) and fasten it with the screws (3).

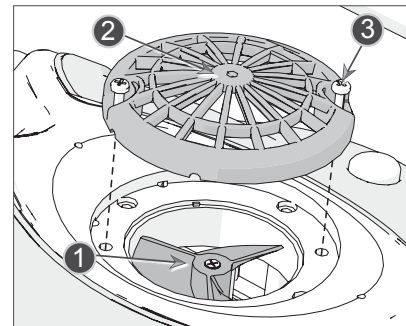

IMPORTANT TIPS:

- Shut off and unplug the power supply every time you remove the cleaner from the water.
- Clean the filter bag after every cycle.
- Periodically straighten out the floating cable.
- Replace worn brushes to ensure maximum cleaning performance
- Save your cleaner's packaging for off-season storage or for shipping the unit to your dealer if service is required.
- Leave your pool cleaner in the water for 15 to 20 minutes after every cleaning cycle.
- **Do not leave your cleaner in direct sunlight when not in use.**
- **Never leave the power supply in direct sunlight and avoid leaving it in the rain.**
- Occasionally, you should rinse your cleaner in clean, fresh water. This will lengthen the service life of the drive belts, drive tracks and scrubbing brushes.
- **Clean the propeller once a month**

CLIMBING UNITS WITH FLOATING HANDLE ONLY

- If your unit has floating handle, reverse the diagonal position after every cleaning cycle to avoid tangling the cable.
- Make sure that your pool cleaner positions itself properly on the wall. The machine handle must rest parallel to the water line upon reaching the surface of the water.

IMPORTANT:

Please be sure to always keep your pool cleaner properly stored anywhere between 10 to 40 degrees Celsius. This will keep the motors, plastics and seals protected. Failure to comply will result in loss of warranty. Robot can be used in water with temperatures ranging from 13°C to 35°C. However, the recommended optimal temperature is between 22°C and 32°C.

IMPORTANT:

The transformer cord can only be replaced with the aid of special tools, normally available only to authorized dealers, distributors and service centers.

CABLE CARE

The cable may become twisted after a period of time in use. To correct this condition, simply lock the moveable handle on the top of the cleaner in the opposite diagonal direction. The pool cleaner will now travel in the opposite direction while cleaning your pool and the cable will uncoil. Check the cable periodically for external damage. If the problem persists, use the E-Z Swivel device.

Place the robot on the ground and unplug the cable from the transformer. With one hand, holding the E-Z Swivel, walk away from the robot, pulling the cable to its full length. The core will rotate inside the cover and in this way will untangle the cable.

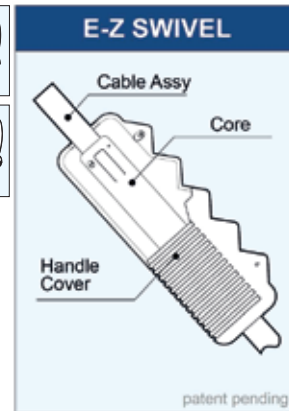
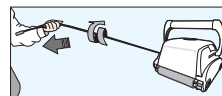
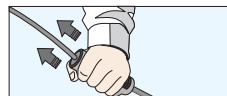
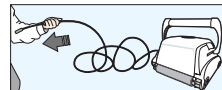

1. CLEANER DOES NOT TURN ON.

There is no electricity in the wall socket.

- a) Disconnect cleaner from the power and control unit.
- b) Disconnect power supply from the wall socket, wait 30 seconds and reconnect.
- c) Turn power ON. If not activated, connect the unit to a different wall socket.

Floating cable not connected properly to the power and control unit.

Reconnect the floating cable to the power and control unit.

Obstacle in the drive system of the cleaner unit.

- a) Turn the cleaner unit carefully to view the underside.
- b) Rotate the tracks and scrubbing brushes by hand. It should rotate but it should not rotate freely.
- c) Clean and remove obstacles and debris if necessary.

Propeller is seized due to accumulation of hair.

Check if the propeller is broken or needs to be cleaned (see “Checking Water Outlet Propeller”).

2. CLEANER MOVES BUT DOES NOT PUMP WATER.

Filter is dirty.

- a) Open the bottom-lid, remove the filter-bag, and close the lid without the bag
- b) Run the robotic cleaner in the pool without the filters. If working properly, clean the filter well or replace the filter.

Propeller is broken or seized due to accumulation of hair.

Check if the propeller is broken or needs cleaning (see “Checking Water Outlet Propeller”).

3. CLEANER PUMPS WATER BUT DOES NOT MOVE.

Obstacle in the drive system of the cleaner unit.

- a) Turn the cleaner unit carefully to view the underside.
- b) Rotate the tracks and scrubbing brushes by hand. It should rotate but it should not rotate freely.
- c) Clean and remove obstacles and debris if necessary.

4. CLEANER STARTS AND SHUTS OFF AFTER A SHORT TIME.

Filter is dirty.

- a) Remove the filter.
- b) Run the robotic cleaner without the filters. If working properly, clean the filters well or replace the filters..

Propeller is broken or seized due to accumulation of hair.

- a) Remove the top screws on the top outlet.
- b) Check if the propeller is broken or needs to be cleaned.

Obstacle in the drive system of the cleaner unit.

- a) Turn the cleaner unit carefully to view the underside.
- b) Rotate the tracks and scrubbing brushes by hand. It should rotate but it should not rotate freely.
- c) Clean and remove obstacles and debris if necessary.

5. CLEANER DOES NOT PICK UP DIRT.

Filter is dirty or has holes.

Clean as needed and verify that there no holes in the filter.

Propeller is broken or seized due to accumulation of hair.

Check if the propeller is broken or needs cleaning (see “Checking Water Outlet Propeller”).

The suction inlet is not close enough to the pool floor.

Move the suction inlet OUT (see “Adjusting Suction Height”).

6. DIRT COMES OUT OF THE CLEANER WHEN REMOVING IT FROM POOL.

Filter shutter is broken or missing.

The filter shutter is located on the bottom lid. Check that both shutters are not broken and function properly.

Holes in the filter.

Verify that there are no holes in the filter (see “Cleaning Filters”)

Bottom lid is not properly closed.

Make sure that the bottom lid is properly closed.

7. CLEANER UNIT DOES NOT COVER THE ENTIRE POOL.

Filter is dirty.

Clean the filter.

There is not enough length of the floating cable in the water to reach the far end of the pool, or the cable is tangled.

- a) Verify that there is enough length of the floating cable in the water to reach the far end of the pool.
- b) Make sure that the floating cable is properly spread out and is not tangled.

The angle of the floating handle affects the cleaner movement.

Increase diagonal angle of the floating handle (see “Adjusting Floating Handle”).

Pool pH level is incorrect.

Make sure that the pH level is between 7.2 and 7.6.

Chlorine level is incorrect.

Check water chlorine treatment and correct if required (Remove the cleaner from the pool during the treatment.)

Propeller is broken or seized due to accumulation of hair.

- a) Remove the top screws on the top outlet.
- b) Check if the propeller is broken or needs cleaning.

Obstacle in the drive system of the cleaner unit.

- a) Turn the cleaner unit carefully to view the underside.
- b) Rotate the tracks and scrubbing brushes by hand. It should rotate but it should not rotate freely.
- c) Clean and remove obstacles and debris if necessary.

8. THE CLEANER DOES NOT CLIMB WALLS.

The cleaner is not climbing the pool walls.

- a) Verify that your robotic cleaner is not a floor-only model.
- b) Verify that P1, floor cleaning only, is not selected on the power and control unit (see “Robotic Cleaner Programming”).

Filter is dirty.

Clean the filter.

Propeller is broken or seized due to accumulation of hair.

Check if the propeller is broken or needs cleaning (see “Checking Water Outlet Propeller”).

pH level is incorrect.

Make sure that pH is between 7.2 and 7.6.

Chlorine level is incorrect.

Check water chlorine treatment (remove the cleaner from the pool during treatment).

Water temperature is not optimal.

Recommended temperature is between 22°C–32°C

9. THE CABLE IS TANGLED.

Filter is dirty.

Clean the filter.

Bottom lid is not properly closed.

Make sure that the bottom lid is properly closed.

Cable is not spread out before putting the cleaner unit into the pool.

Make sure that the floating cable is properly spread out and not tangled before operating the robotic cleaner.

The length of the cable in the water is too long.

Verify that the length of cable in the water equal to the pool diagonal length plus two meters.

Propeller is broken or seized due to accumulation of hair.

Check if the propeller is broken or needs cleaning (see “Checking Water Outlet Propeller”).

Astral Pool Australia Pty Ltd (ABN 97 007 284 504) ("Astral Pool") provides the following warranty in relation to its Robotic Pool Cleaners.

Our goods come with guarantees that cannot be excluded under the Australian Consumer Law. You are entitled to a replacement or refund for a major failure and for compensation for any other reasonably foreseeable loss or damage. You are also entitled to have the goods repaired or replaced if the goods fail to be of acceptable quality and the failure does not amount to a major failure.

The benefits of this warranty are in addition to any rights and remedies imposed by Australian state and federal legislation that cannot be excluded. Nothing in this warranty is to be interpreted as excluding, restricting or modifying any state or federal legislation applicable to the supply of goods and services which cannot be excluded, restricted or modified.

Your Astralpool Robotic Pool Cleaner is covered by a limited 2 year warranty against defect in material and assembly.

| Parts | Warranty Period |
|---|-----------------|
| Robot Motor, Drives and Electrical System | 2 Years |
| Transformer | 2 Years |
| The rollers, tracks, pulleys, filter cartridge or bag | 1 Year |
| Trolley (if included) | 1 Year |

This warranty is for residential use only. If cleaner is being used in a commercial or communal pool then warranty period is 12 months.

1. If a fault covered by warranty occurs, the customer must first contact AstralPool at the contact address listed below, or an Authorised AstralPool Service Agent.
2. Any warranty claim must be accompanied by:
 - (a) proof of purchase;
 - (b) full details of the alleged defect; and
 - (c) appropriate documentation (such as historical and maintenance records).
3. The customer must make the Product available to AstralPool or its Authorised AstralPool Service Agent for inspection and testing. AstralPool or its Authorised AstralPool Service Agent will attend the premises where the Product is installed for inspection and testing.
4. If such inspection and testing finds no defect in the Product, the customer must pay AstralPool's usual costs of service work and testing. If such inspection and testing finds a defect that is not covered by this warranty, the customer must pay AstralPool's usual costs of service work plus any parts and labour required to repair the Product, unless recoverable from AstralPool on the failure of any statutory guarantee under the ACL.
5. If your Robot Cleaner needs to be returned to Astralpool the following is required:
 - (a) Your Robot Cleaner must be packaged carefully including your name, address and contact number.
 - (b) Delivered freight prepaid to your nearest AstralPool Warehouse.
 - (c) You must also include a copy of your invoice showing date of purchase or date of handover of your swimming pool.
 - (d) Description of the fault.
6. For Service please return to your nearest AstralPool Trade Centre which can be found at:
<http://www.astralpool.com.au/contact>

EXCLUSIONS

The warranty will not apply where:

- (a) the customer is in breach of the Terms and Conditions of Sale;
- (b) the Product was used for a purpose other than one it was intended for;
- (c) the Product was repaired, modified or altered by any person other than AstralPool;
- (d) the Product has not been installed, maintained and/or operated in complete compliance with the installation and operating instructions and any instructions by AstralPool;
- (e) the Product has been subject to accident, negligence, alteration, abuse or misuse.

The warranty does not extend to:

- a) normal wear and tear;
- b) weather and other environmental conditions including but not limited to storm, flood, and/or heat wave damage; or
- c) service and maintenance items.

Examples of exclusions include but are not limited to:

- Incorrect installation
- External power spikes / surge
- Normal wear and tear of consumable parts such as rollers, pulleys, drive belts and filter cartridge/bag

LIMITATIONS

AstralPool makes no express warranties or representations other than set out in this warranty.

The repair or replacement of the Product or part of the Product is the absolute limit of AstralPool's liability under this express warranty.